

SCHWARZBECK MESS - ELEKTRONIK

An der Klinge 29 D-69250 Schönau Tel.: (+49)6228/1001

Fax.: (+49)6228/1003 E-mail: office@schwarzbeck.de

VHBD 9134-4

**4:1 Hochleistungs-Balun für
Störfestigkeitsprüfungen**

4:1 High-Power-Balun for Immunity Testing

20 MHz ... 200 MHz

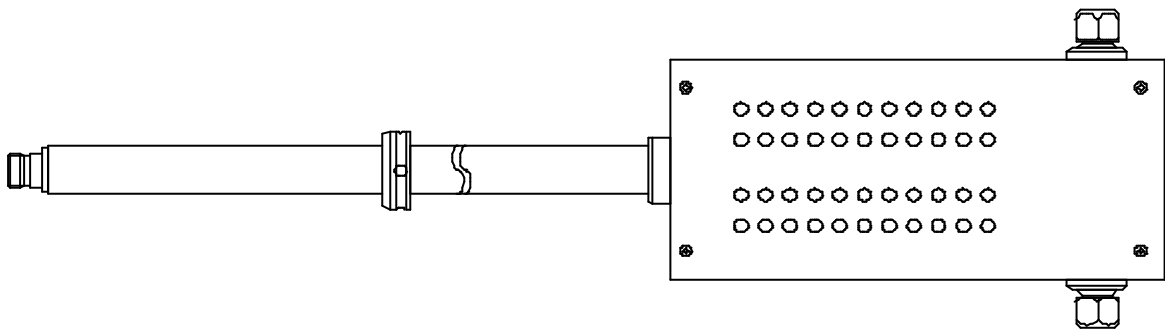

Handbuch
Manual

SCHWARZBECK MESS - ELEKTRONIK

An der Klinge 29 D-69250 Schönau Tel.: 06228/1001 Fax.: (49)6228/1003

Hochleistungs-Breitband Balun / Halter VHBD 9134-4 High Power Broadband Balun / Holder VHBD 9134-4

Technische Daten:

Bauart:
Hochleistungs Guanella-Balun 4:1
auf PTFE-Wickelkörper mit 10 mm
Spannzangen zur Elementaufnahme.
Frequenzbereich, nominell: 20 - 200 MHz
Impedanz: 50 Ω
Antennenwandlungsmaß:
(abhängig vom Elementtyp und
Frequenzbereich) typ. 6-17 dB/m
(BBAL 9136)
Länge Halterung: LH=670 mm

Breite: je nach Elementtyp
(siehe Tabelle Zubehör)
Antennenschaft (Halterungsrohr) \varnothing 22 mm
Gewicht: 2.8 kg

Koaxialanschluß: 7/16 Buchse / female
Belastbarkeit 7/16 Buchse:
5 kW f < 80 MHz
4.5 kW f < 100 MHz
3.5 kW f < 150 MHz
3 kW f < 200 MHz

Empfohlenes Zubehör:

BBAL 9136 Bikonus-Elemente LE=1.98 m, D=0.5 m
BBA 9106 Bikonus-Elemente LE=1.37 m, D=0.5 m
BBFA 9146 Faltbikonus-Elemente LE & D variabel

Specifications:

Type:
High Power Guanella Balun 4:1 on
PTFE body with 10 mm element
fixtures.
Frequency Range, nominal:
Impedance:
Antenna Factor:
(depending on elem. type in use
and frequency range)
Length holder: LH=670 mm

Width depends on elements used
(see table accessories below)
Antenna shaft (Tube):
Weight:

Coaxial Connector:
Power Rating 7/16 Connector:

Recommended Accessories:

BBAL 9136 Biconical Elements
BBA 9106 Biconical Elements
BBFA 9146 Collapsible Biconical
Elements

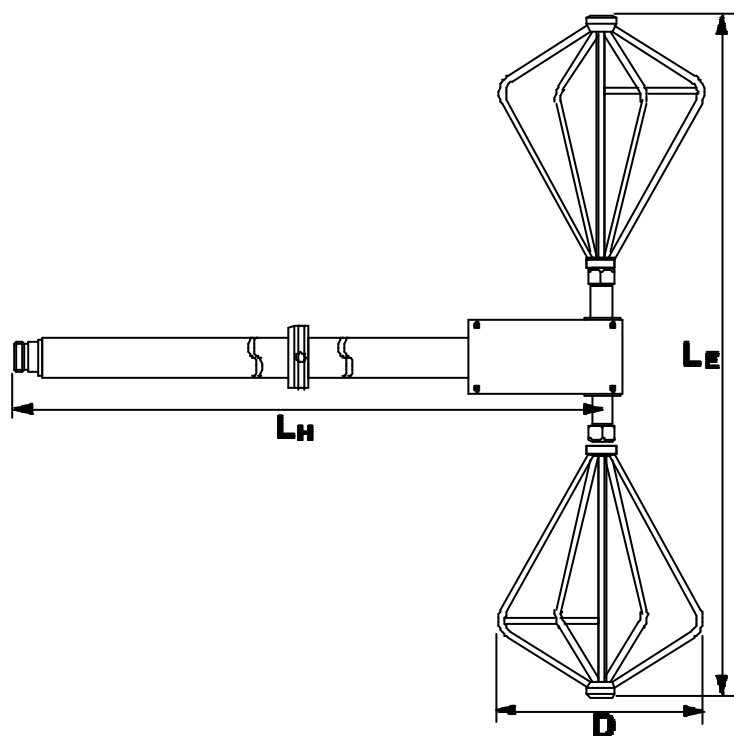

SCHWARZBECK MESS - ELEKTRONIK

An der Klinge 29 D-69250 Schönau Tel.: 06228/1001 Fax.: (49)6228/1003

Hochleistungs-Breitband Balun / Halter VHBD 9134-4 + BBA 9106 Elemente High Power Broadband Balun / Holder VHBD 9134-4 + BBA 9106 Elements

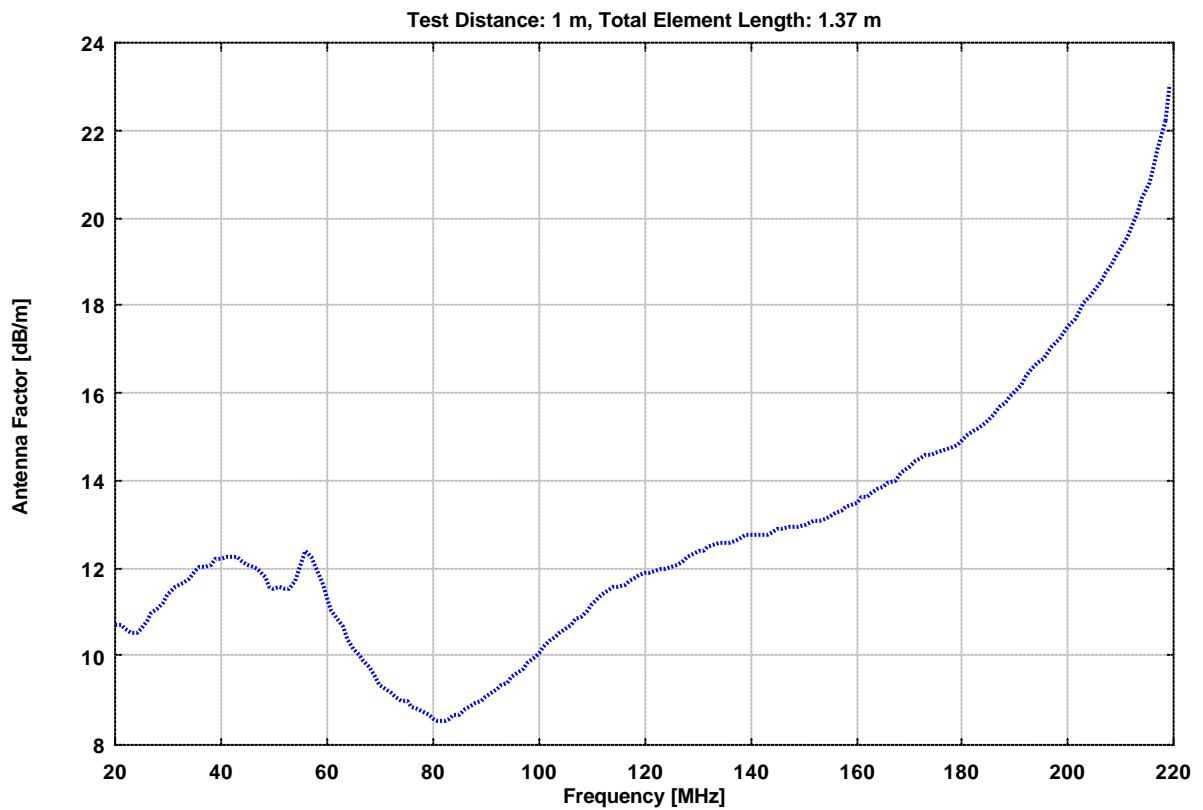
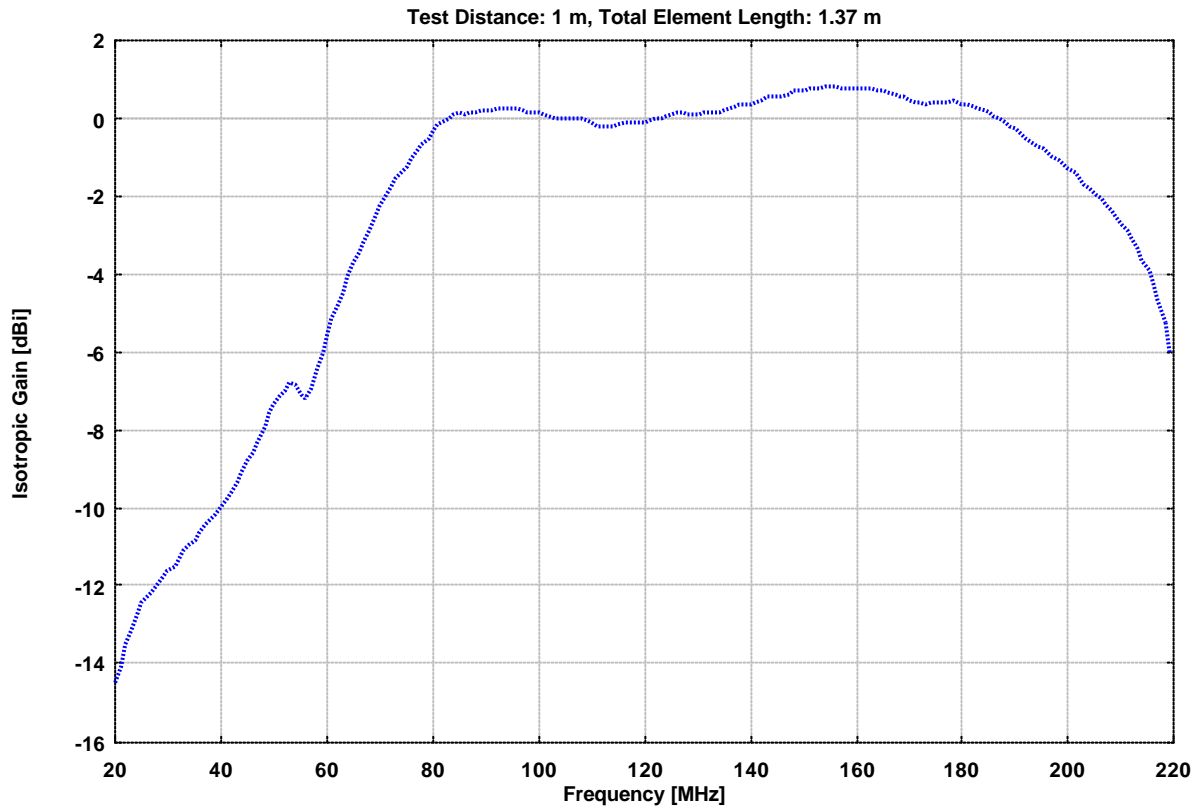

SCHWARZBECK MESS - ELEKTRONIK

An der Klinge 29 D-69250 Schönau Tel.: 06228/1001 Fax.: (49)6228/1003

Hochleistungs-Breitband Balun / Halter VHBD 9134-4 + BBA 9106 Elemente High Power Broadband Balun / Holder VHBD 9134-4 + BBA 9106 Elements

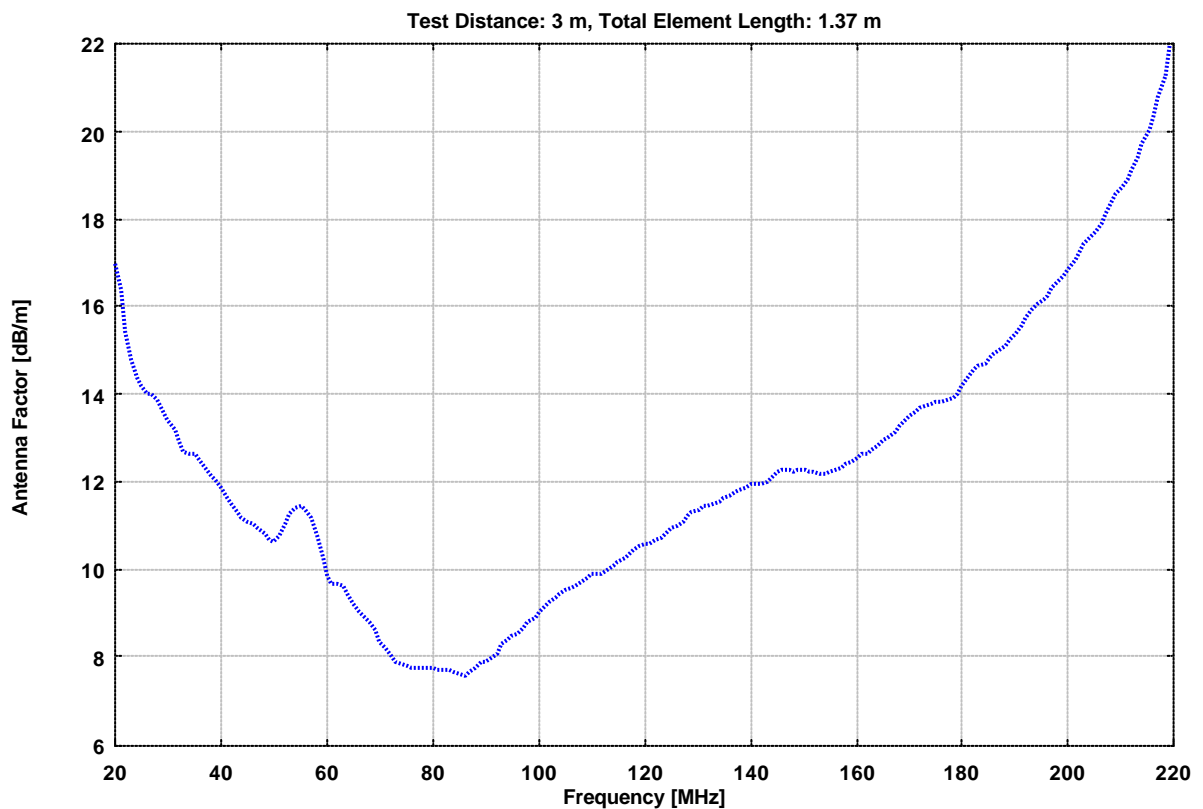
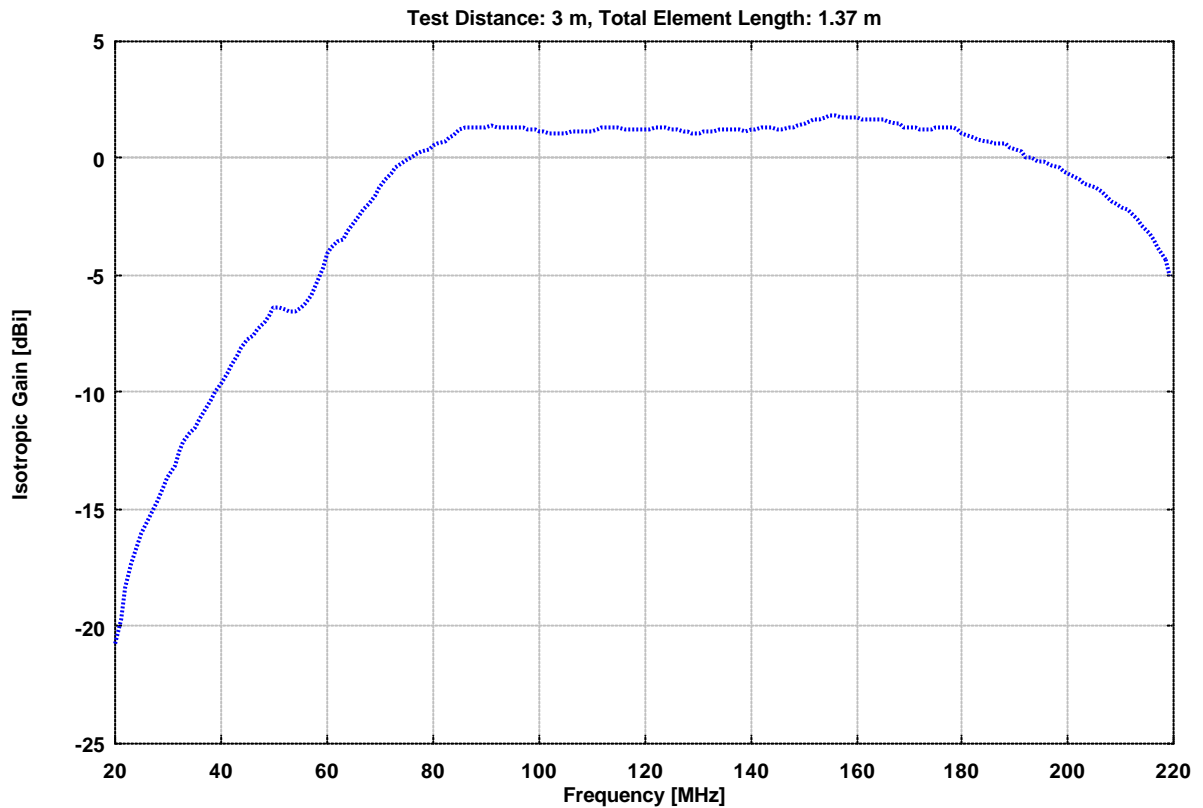

SCHWARZBECK MESS - ELEKTRONIK

An der Klinge 29 D-69250 Schönau Tel.: 06228/1001 Fax.: (49)6228/1003

Hochleistungs-Breitband Balun / Halter VHBD 9134-4 + BBA 9106 Elemente High Power Broadband Balun / Holder VHBD 9134-4 + BBA 9106 Elements

Frequency	Gain(Isotr.) 1 m	Ant.-Factor 1 m	Gain(Isotr.) 3 m	Ant.-Factor 3 m
MHz	dBm	dB/m	dBm	dB/m
20.00	-14.50	10.74	-20.75	16.99
21.00	-14.08	10.74	-19.73	16.39
22.00	-13.55	10.62	-18.37	15.44
23.00	-13.11	10.56	-17.36	14.81
24.00	-12.74	10.56	-16.58	14.41
25.00	-12.45	10.63	-16.00	14.18
26.00	-12.28	10.80	-15.53	14.05
27.00	-12.15	10.99	-15.18	14.03
28.00	-11.94	11.10	-14.69	13.85
29.00	-11.74	11.20	-14.15	13.62
30.00	-11.62	11.38	-13.64	13.40
31.00	-11.52	11.57	-13.14	13.19
32.00	-11.33	11.65	-12.60	12.92
33.00	-11.09	11.68	-12.10	12.69
34.00	-10.94	11.79	-11.78	12.63
35.00	-10.85	11.95	-11.53	12.64
36.00	-10.67	12.01	-11.17	12.51
37.00	-10.46	12.04	-10.75	12.33
38.00	-10.29	12.11	-10.36	12.17
39.00	-10.16	12.20	-10.00	12.04
40.00	-9.97	12.23	-9.59	11.86
41.00	-9.77	12.24	-9.18	11.66
42.00	-9.59	12.28	-8.83	11.51
43.00	-9.37	12.26	-8.45	11.33
44.00	-9.08	12.17	-8.08	11.17
45.00	-8.79	12.07	-7.79	11.07
46.00	-8.57	12.04	-7.57	11.05
47.00	-8.32	11.98	-7.32	10.98
48.00	-7.95	11.80	-6.97	10.82
49.00	-7.58	11.61	-6.66	10.68
50.00	-7.33	11.53	-6.44	10.64
51.00	-7.18	11.55	-6.40	10.78
52.00	-6.99	11.53	-6.50	11.04
53.00	-6.80	11.51	-6.56	11.26
54.00	-6.86	11.73	-6.53	11.39
55.00	-7.09	12.12	-6.40	11.42
56.00	-7.20	12.38	-6.20	11.38
57.00	-6.91	12.24	-5.84	11.18
58.00	-6.45	11.94	-5.26	10.74
59.00	-5.99	11.62	-4.62	10.26
60.00	-5.54	11.32	-4.07	9.85
61.00	-5.13	11.06	-3.75	9.68
62.00	-4.79	10.85	-3.59	9.66
63.00	-4.45	10.66	-3.43	9.64
64.00	-4.07	10.41	-3.11	9.45
65.00	-3.69	10.17	-2.75	9.23
66.00	-3.42	10.03	-2.44	9.05
67.00	-3.17	9.91	-2.22	8.96
68.00	-2.88	9.75	-1.93	8.80

SCHWARZBECK MESS - ELEKTRONIK

An der Klinge 29 D-69250 Schönau Tel.: 06228/1001 Fax.: (49)6228/1003

Hochleistungs-Breitband Balun / Halter VHBD 9134-4 + BBA 9106 Elemente High Power Broadband Balun / Holder VHBD 9134-4 + BBA 9106 Elements

Frequency	Gain(Isotr.) 1 m	Ant.-Factor 1 m	Gain(Isotr.) 3 m	Ant.-Factor 3 m
MHz	dBm	dB/m	dBm	dB/m
69.00	-2.53	9.53	-1.61	8.61
70.00	-2.24	9.36	-1.25	8.37
71.00	-2.00	9.25	-0.93	8.18
72.00	-1.78	9.15	-0.63	8.00
73.00	-1.57	9.06	-0.40	7.88
74.00	-1.39	8.99	-0.22	7.82
75.00	-1.23	8.95	-0.08	7.80
76.00	-1.04	8.87	0.06	7.77
77.00	-0.84	8.79	0.20	7.75
78.00	-0.67	8.73	0.31	7.75
79.00	-0.49	8.66	0.42	7.75
80.00	-0.30	8.58	0.54	7.74
81.00	-0.14	8.53	0.67	7.72
82.00	-0.04	8.53	0.76	7.73
83.00	0.03	8.57	0.88	7.72
84.00	0.09	8.62	1.04	7.67
85.00	0.13	8.68	1.21	7.60
86.00	0.12	8.79	1.35	7.56
87.00	0.14	8.87	1.38	7.63
88.00	0.18	8.93	1.36	7.75
89.00	0.23	8.98	1.33	7.88
90.00	0.23	9.08	1.40	7.91
91.00	0.23	9.17	1.42	7.98
92.00	0.25	9.25	1.40	8.10
93.00	0.27	9.32	1.31	8.28
94.00	0.27	9.41	1.28	8.40
95.00	0.28	9.49	1.29	8.49
96.00	0.27	9.60	1.31	8.55
97.00	0.24	9.72	1.29	8.66
98.00	0.19	9.86	1.25	8.79
99.00	0.16	9.97	1.22	8.92
100.00	0.13	10.09	1.19	9.03
101.00	0.10	10.21	1.17	9.14
102.00	0.07	10.33	1.13	9.26
103.00	0.04	10.44	1.11	9.36
104.00	0.02	10.54	1.11	9.45
105.00	0.01	10.64	1.12	9.53
106.00	-0.00	10.73	1.14	9.59
107.00	-0.01	10.82	1.16	9.65
108.00	-0.03	10.91	1.15	9.73
109.00	-0.07	11.04	1.14	9.82
110.00	-0.12	11.17	1.15	9.89
111.00	-0.17	11.30	1.21	9.91
112.00	-0.19	11.40	1.27	9.93
113.00	-0.20	11.48	1.30	9.98
114.00	-0.18	11.54	1.29	10.06
115.00	-0.14	11.58	1.28	10.16
116.00	-0.11	11.62	1.26	10.25
117.00	-0.10	11.69	1.22	10.36
118.00	-0.11	11.77	1.20	10.46
119.00	-0.11	11.84	1.20	10.53

SCHWARZBECK MESS - ELEKTRONIK

An der Klinge 29 D-69250 Schönau Tel.: 06228/1001 Fax.: (49)6228/1003

Hochleistungs-Breitband Balun / Halter VHBD 9134-4 + BBA 9106 Elemente High Power Broadband Balun / Holder VHBD 9134-4 + BBA 9106 Elements

Frequency	Gain(Isotr.) 1 m	Ant.-Factor 1 m	Gain(Isotr.) 3 m	Ant.-Factor 3 m
MHz	dB	dB/m	dB	dB/m
120.00	-0.09	11.89	1.22	10.58
121.00	-0.05	11.93	1.26	10.61
122.00	-0.00	11.95	1.29	10.66
123.00	0.04	11.98	1.28	10.73
124.00	0.08	12.00	1.27	10.82
125.00	0.12	12.03	1.24	10.92
126.00	0.15	12.08	1.22	11.01
127.00	0.14	12.16	1.18	11.12
128.00	0.12	12.25	1.14	11.23
129.00	0.11	12.33	1.11	11.32
130.00	0.11	12.38	1.12	11.38
131.00	0.13	12.44	1.14	11.43
132.00	0.14	12.49	1.15	11.48
133.00	0.16	12.54	1.18	11.52
134.00	0.20	12.56	1.21	11.56
135.00	0.24	12.58	1.22	11.61
136.00	0.28	12.61	1.22	11.67
137.00	0.31	12.65	1.21	11.74
138.00	0.33	12.69	1.20	11.82
139.00	0.34	12.74	1.19	11.89
140.00	0.36	12.78	1.20	11.94
141.00	0.41	12.79	1.25	11.95
142.00	0.48	12.79	1.31	11.96
143.00	0.53	12.80	1.33	12.00
144.00	0.54	12.84	1.28	12.10
145.00	0.56	12.89	1.24	12.21
146.00	0.59	12.91	1.25	12.25
147.00	0.65	12.92	1.31	12.25
148.00	0.69	12.94	1.39	12.24
149.00	0.70	12.98	1.44	12.25
150.00	0.73	13.02	1.49	12.25
151.00	0.75	13.05	1.56	12.24
152.00	0.78	13.08	1.64	12.22
153.00	0.81	13.11	1.72	12.19
154.00	0.83	13.14	1.78	12.19
155.00	0.84	13.19	1.82	12.21
156.00	0.82	13.26	1.81	12.28
157.00	0.81	13.33	1.79	12.34
158.00	0.81	13.39	1.79	12.40
159.00	0.81	13.44	1.79	12.46
160.00	0.78	13.52	1.75	12.55
161.00	0.76	13.60	1.72	12.63
162.00	0.76	13.65	1.73	12.68
163.00	0.75	13.71	1.72	12.74
164.00	0.72	13.79	1.68	12.84
165.00	0.69	13.88	1.62	12.95
166.00	0.66	13.96	1.58	13.04
167.00	0.64	14.03	1.53	13.14
168.00	0.60	14.13	1.47	13.26
169.00	0.54	14.23	1.39	13.38
170.00	0.49	14.34	1.33	13.50

SCHWARZBECK MESS - ELEKTRONIK

An der Klinge 29 D-69250 Schönau Tel.: 06228/1001 Fax.: (49)6228/1003

Hochleistungs-Breitband Balun / Halter VHBD 9134-4 + BBA 9106 Elemente High Power Broadband Balun / Holder VHBD 9134-4 + BBA 9106 Elements

Frequency	Gain(Isotr.) 1 m	Ant.-Factor 1 m	Gain(Isotr.) 3 m	Ant.-Factor 3 m
MHz	dB	dB/m	dB	dB/m
171.00	0.44	14.44	1.28	13.60
172.00	0.41	14.52	1.25	13.69
173.00	0.40	14.58	1.22	13.76
174.00	0.43	14.60	1.24	13.79
175.00	0.44	14.64	1.28	13.80
176.00	0.44	14.69	1.32	13.81
177.00	0.44	14.74	1.32	13.86
178.00	0.45	14.78	1.30	13.93
179.00	0.44	14.84	1.22	14.05
180.00	0.39	14.93	1.11	14.22
181.00	0.33	15.05	0.97	14.40
182.00	0.29	15.14	0.88	14.54
183.00	0.26	15.21	0.83	14.64
184.00	0.22	15.30	0.78	14.73
185.00	0.15	15.41	0.73	14.83
186.00	0.08	15.53	0.69	14.92
187.00	0.00	15.66	0.66	15.00
188.00	-0.09	15.79	0.60	15.10
189.00	-0.19	15.94	0.50	15.25
190.00	-0.28	16.08	0.39	15.41
191.00	-0.39	16.23	0.26	15.59
192.00	-0.52	16.41	0.11	15.78
193.00	-0.64	16.57	-0.03	15.96
194.00	-0.71	16.69	-0.10	16.08
195.00	-0.77	16.79	-0.14	16.16
196.00	-0.87	16.93	-0.22	16.28
197.00	-0.98	17.09	-0.33	16.44
198.00	-1.09	17.24	-0.43	16.58
199.00	-1.17	17.37	-0.51	16.71
200.00	-1.28	17.52	-0.61	16.85
201.00	-1.41	17.69	-0.77	17.06
202.00	-1.54	17.87	-0.93	17.26
203.00	-1.67	18.04	-1.06	17.43
204.00	-1.80	18.21	-1.16	17.57
205.00	-1.93	18.38	-1.26	17.71
206.00	-2.05	18.55	-1.40	17.89
207.00	-2.20	18.74	-1.59	18.12
208.00	-2.36	18.94	-1.79	18.38
209.00	-2.53	19.15	-1.96	18.58
210.00	-2.70	19.36	-2.06	18.72
211.00	-2.86	19.57	-2.18	18.89
212.00	-3.07	19.82	-2.37	19.12
213.00	-3.33	20.12	-2.63	19.42
214.00	-3.62	20.45	-2.92	19.74
215.00	-3.92	20.78	-3.20	20.07
216.00	-4.25	21.16	-3.49	20.40
217.00	-4.65	21.60	-3.83	20.78
218.00	-5.22	22.21	-4.30	21.29
219.00	-5.99	23.02	-4.96	21.99

SCHWARZBECK MESS - ELEKTRONIK

An der Klinge 29 D-69250 Schönau Tel.: 06228/1001 Fax.: (49)6228/1003

Hochleistungs-Breitband Balun / Halter VHBD 9134-4 + BBAL 9136 Elemente High Power Broadband Balun / Holder VHBD 9134-4 + BBAL 9136 Elements

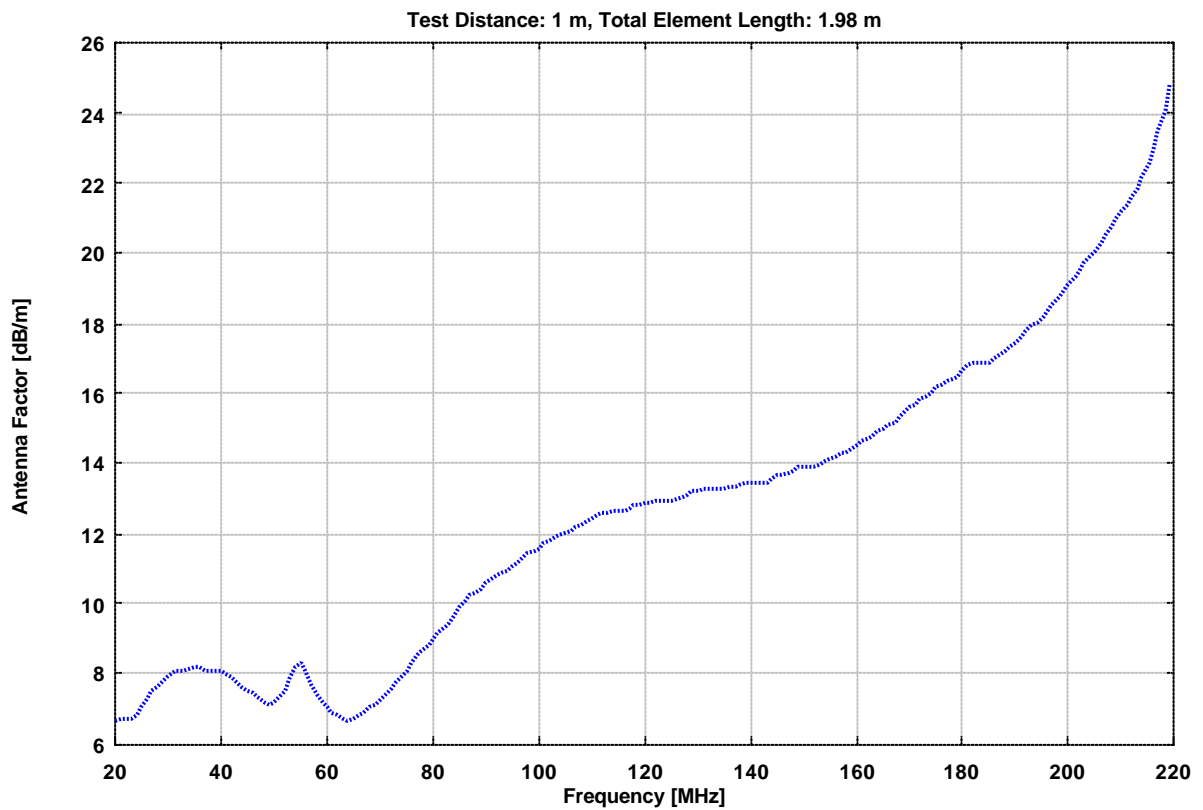
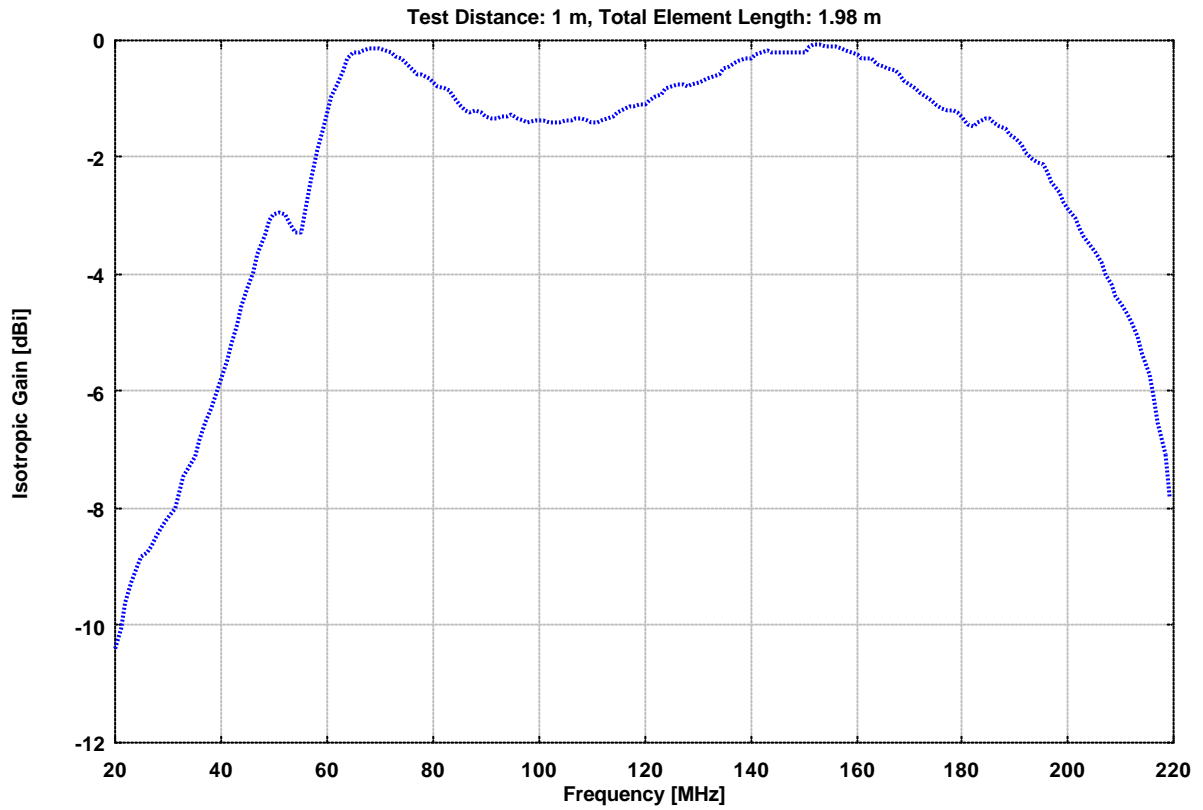

SCHWARZBECK MESS - ELEKTRONIK

An der Klinge 29 D-69250 Schönau Tel.: 06228/1001 Fax.: (49)6228/1003

Hochleistungs-Breitband Balun / Halter VHBD 9134-4 + BBAL 9136 Elemente High Power Broadband Balun / Holder VHBD 9134-4 + BBAL 9136 Elements

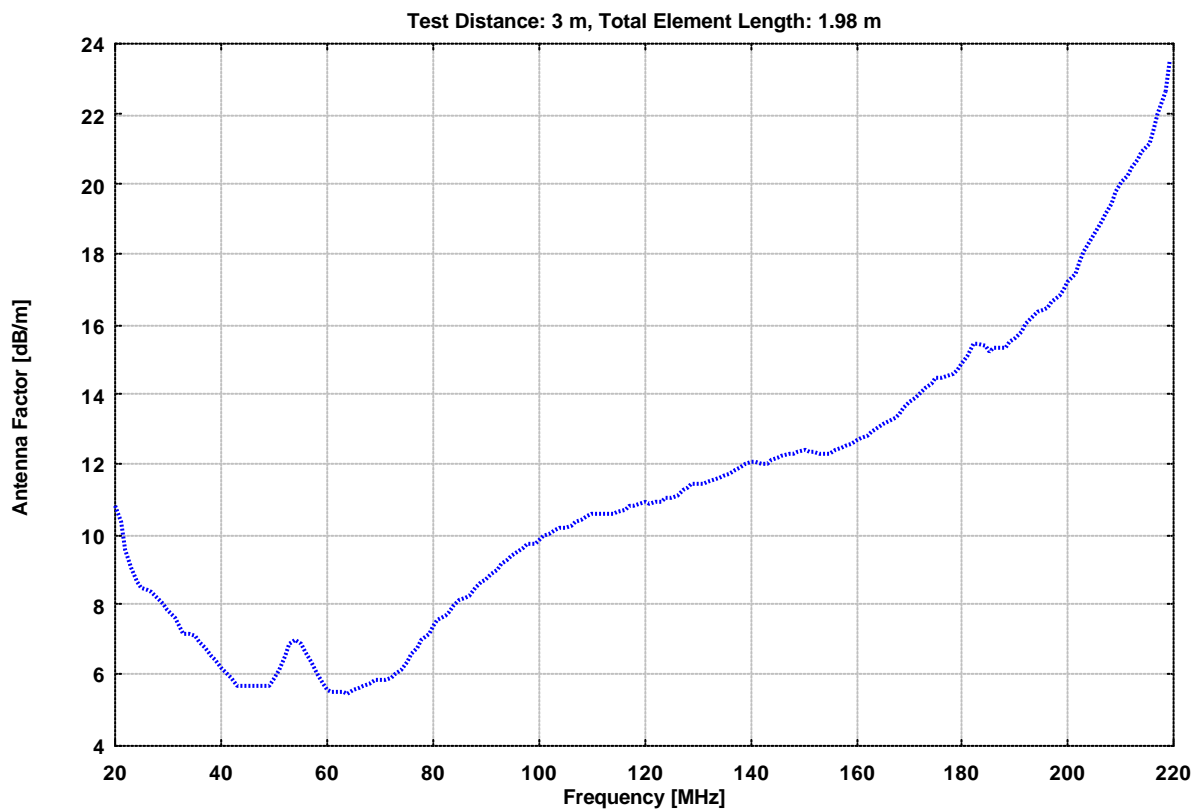
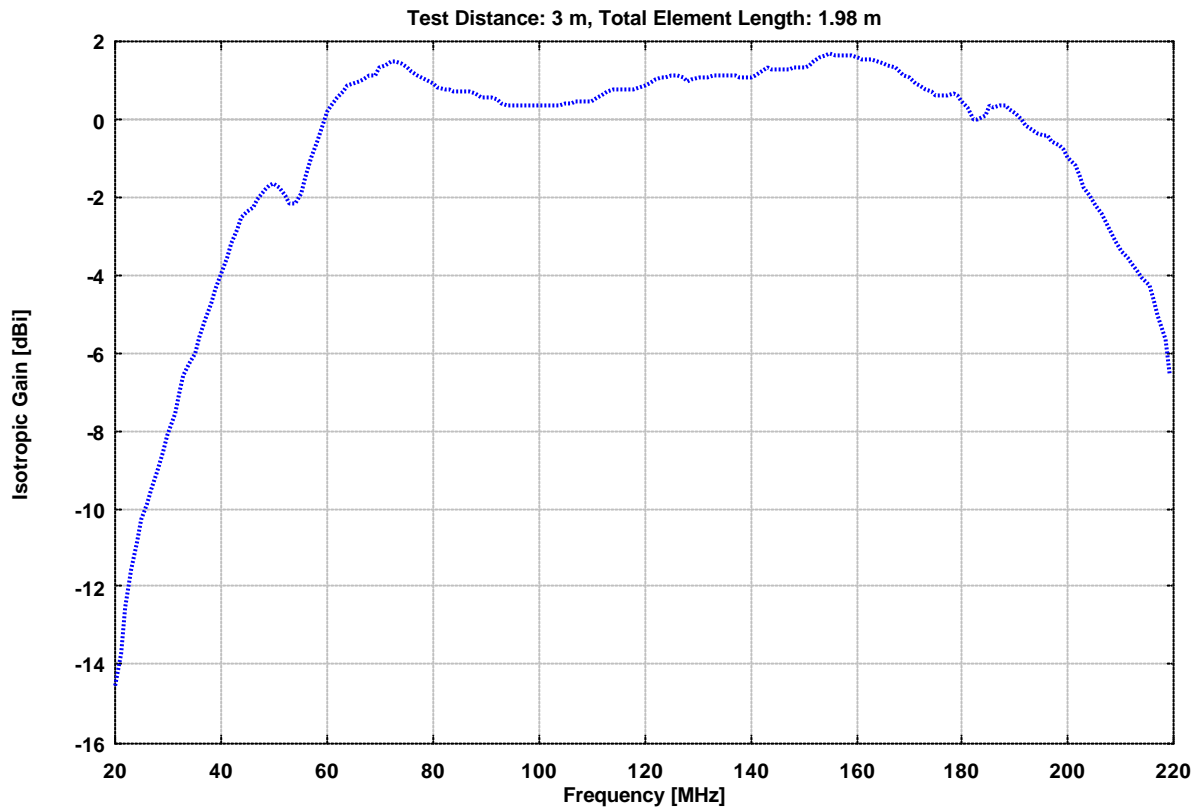

SCHWARZBECK MESS - ELEKTRONIK

An der Klinge 29 D-69250 Schönau Tel.: 06228/1001 Fax.: (49)6228/1003

Hochleistungs-Breitband Balun / Halter VHBD 9134-4 + BBAL 9136 Elemente High Power Broadband Balun / Holder VHBD 9134-4 + BBAL 9136 Elements

Frequency	Gain(Isotr.) 1 m	Ant.-Factor 1 m	Gain(Isotr.) 3 m	Ant.-Factor 3 m
MHz	dBm	dB/m	dBm	dB/m
20.00	-10.41	6.65	-14.57	10.81
21.00	-10.05	6.71	-13.69	10.36
22.00	-9.62	6.69	-12.50	9.56
23.00	-9.28	6.73	-11.56	9.02
24.00	-9.01	6.84	-10.84	8.66
25.00	-8.84	7.02	-10.31	8.49
26.00	-8.75	7.27	-9.89	8.41
27.00	-8.66	7.51	-9.53	8.38
28.00	-8.47	7.63	-9.04	8.20
29.00	-8.30	7.77	-8.55	8.02
30.00	-8.18	7.94	-8.09	7.85
31.00	-8.01	8.05	-7.59	7.64
32.00	-7.73	8.05	-7.04	7.37
33.00	-7.46	8.05	-6.57	7.16
34.00	-7.29	8.14	-6.27	7.12
35.00	-7.11	8.21	-5.98	7.09
36.00	-6.83	8.18	-5.57	6.92
37.00	-6.55	8.13	-5.14	6.73
38.00	-6.31	8.13	-4.75	6.56
39.00	-6.07	8.11	-4.37	6.41
40.00	-5.78	8.04	-3.96	6.22
41.00	-5.48	7.95	-3.55	6.03
42.00	-5.20	7.88	-3.19	5.88
43.00	-4.87	7.76	-2.82	5.71
44.00	-4.53	7.62	-2.55	5.64
45.00	-4.23	7.51	-2.38	5.66
46.00	-3.97	7.44	-2.25	5.72
47.00	-3.66	7.32	-2.04	5.70
48.00	-3.32	7.16	-1.81	5.66
49.00	-3.07	7.09	-1.67	5.70
50.00	-2.97	7.17	-1.65	5.85
51.00	-2.95	7.32	-1.77	6.14
52.00	-2.96	7.50	-1.96	6.50
53.00	-3.11	7.82	-2.14	6.85
54.00	-3.31	8.18	-2.13	6.99
55.00	-3.30	8.33	-1.87	6.89
56.00	-2.91	8.09	-1.46	6.64
57.00	-2.37	7.70	-1.01	6.35
58.00	-1.89	7.38	-0.54	6.03
59.00	-1.51	7.15	-0.12	5.76
60.00	-1.21	7.00	0.22	5.57
61.00	-0.97	6.90	0.40	5.53
62.00	-0.74	6.80	0.53	5.53
63.00	-0.50	6.70	0.69	5.52
64.00	-0.32	6.66	0.85	5.49
65.00	-0.22	6.70	0.94	5.54
66.00	-0.20	6.81	1.01	5.60
67.00	-0.16	6.90	1.05	5.69
68.00	-0.14	7.01	1.13	5.74

SCHWARZBECK MESS - ELEKTRONIK

An der Klinge 29 D-69250 Schönau Tel.: 06228/1001 Fax.: (49)6228/1003

Hochleistungs-Breitband Balun / Halter VHBD 9134-4 + BBAL 9136 Elemente High Power Broadband Balun / Holder VHBD 9134-4 + BBAL 9136 Elements

Frequency	Gain(Isotr.) 1 m	Ant.-Factor 1 m	Gain(Isotr.) 3 m	Ant.-Factor 3 m
MHz	dBm	dB/m	dBm	dB/m
69.00	-0.12	7.11	1.18	5.82
70.00	-0.13	7.25	1.30	5.82
71.00	-0.15	7.39	1.41	5.83
72.00	-0.19	7.56	1.49	5.88
73.00	-0.26	7.74	1.47	6.01
74.00	-0.33	7.93	1.43	6.17
75.00	-0.40	8.12	1.35	6.37
76.00	-0.48	8.31	1.26	6.58
77.00	-0.55	8.50	1.15	6.80
78.00	-0.59	8.66	1.06	7.00
79.00	-0.64	8.81	0.99	7.18
80.00	-0.71	8.99	0.90	7.38
81.00	-0.78	9.17	0.83	7.56
82.00	-0.82	9.32	0.79	7.71
83.00	-0.86	9.47	0.77	7.83
84.00	-0.95	9.66	0.73	7.97
85.00	-1.08	9.89	0.70	8.11
86.00	-1.18	10.09	0.73	8.18
87.00	-1.20	10.21	0.72	8.29
88.00	-1.19	10.30	0.67	8.44
89.00	-1.21	10.42	0.57	8.64
90.00	-1.28	10.58	0.56	8.74
91.00	-1.32	10.72	0.55	8.85
92.00	-1.33	10.83	0.51	8.99
93.00	-1.30	10.89	0.42	9.17
94.00	-1.28	10.96	0.40	9.28
95.00	-1.27	11.05	0.39	9.38
96.00	-1.32	11.18	0.39	9.48
97.00	-1.37	11.32	0.35	9.61
98.00	-1.39	11.43	0.34	9.70
99.00	-1.37	11.50	0.37	9.76
100.00	-1.36	11.58	0.39	9.83
101.00	-1.38	11.69	0.39	9.92
102.00	-1.40	11.80	0.38	10.01
103.00	-1.40	11.88	0.38	10.10
104.00	-1.39	11.95	0.39	10.17
105.00	-1.37	12.02	0.41	10.23
106.00	-1.36	12.09	0.44	10.28
107.00	-1.35	12.16	0.46	10.35
108.00	-1.35	12.24	0.46	10.43
109.00	-1.36	12.33	0.45	10.52
110.00	-1.39	12.43	0.48	10.57
111.00	-1.40	12.52	0.56	10.57
112.00	-1.38	12.58	0.65	10.55
113.00	-1.34	12.62	0.72	10.56
114.00	-1.28	12.64	0.75	10.60
115.00	-1.21	12.65	0.78	10.65
116.00	-1.16	12.67	0.80	10.71
117.00	-1.13	12.71	0.80	10.78
118.00	-1.12	12.78	0.80	10.85
119.00	-1.11	12.84	0.83	10.90

SCHWARZBECK MESS - ELEKTRONIK

An der Klinge 29 D-69250 Schönau Tel.: 06228/1001 Fax.: (49)6228/1003

Hochleistungs-Breitband Balun / Halter VHBD 9134-4 + BBAL 9136 Elemente High Power Broadband Balun / Holder VHBD 9134-4 + BBAL 9136 Elements

Frequency	Gain(Isotr.) 1 m	Ant.-Factor 1 m	Gain(Isotr.) 3 m	Ant.-Factor 3 m
MHz	dBm	dB/m	dBm	dB/m
120.00	-1.07	12.87	0.89	10.91
121.00	-1.02	12.89	0.97	10.90
122.00	-0.96	12.91	1.03	10.92
123.00	-0.90	12.92	1.06	10.95
124.00	-0.84	12.92	1.09	11.00
125.00	-0.77	12.93	1.11	11.04
126.00	-0.74	12.96	1.11	11.12
127.00	-0.75	13.04	1.06	11.23
128.00	-0.77	13.13	1.02	11.34
129.00	-0.75	13.18	1.03	11.41
130.00	-0.70	13.20	1.06	11.44
131.00	-0.67	13.24	1.08	11.49
132.00	-0.65	13.28	1.09	11.54
133.00	-0.61	13.31	1.12	11.58
134.00	-0.55	13.31	1.15	11.62
135.00	-0.49	13.31	1.16	11.67
136.00	-0.43	13.32	1.14	11.75
137.00	-0.38	13.34	1.12	11.83
138.00	-0.35	13.37	1.09	11.93
139.00	-0.33	13.41	1.06	12.02
140.00	-0.30	13.44	1.09	12.06
141.00	-0.24	13.44	1.17	12.04
142.00	-0.18	13.44	1.26	12.00
143.00	-0.16	13.49	1.31	12.02
144.00	-0.18	13.57	1.29	12.10
145.00	-0.19	13.64	1.27	12.18
146.00	-0.18	13.69	1.27	12.23
147.00	-0.18	13.74	1.29	12.28
148.00	-0.18	13.81	1.30	12.32
149.00	-0.19	13.87	1.32	12.36
150.00	-0.18	13.93	1.34	12.40
151.00	-0.10	13.90	1.42	12.38
152.00	-0.08	13.94	1.49	12.37
153.00	-0.05	13.96	1.59	12.32
154.00	-0.09	14.06	1.64	12.33
155.00	-0.09	14.11	1.67	12.35
156.00	-0.11	14.20	1.66	12.42
157.00	-0.13	14.27	1.66	12.48
158.00	-0.15	14.34	1.65	12.54
159.00	-0.18	14.43	1.64	12.61
160.00	-0.24	14.54	1.59	12.71
161.00	-0.28	14.63	1.57	12.79
162.00	-0.29	14.70	1.57	12.84
163.00	-0.33	14.79	1.54	12.93
164.00	-0.39	14.91	1.47	13.04
165.00	-0.44	15.01	1.43	13.14
166.00	-0.47	15.09	1.40	13.22
167.00	-0.51	15.18	1.35	13.32
168.00	-0.59	15.31	1.26	13.47
169.00	-0.68	15.45	1.16	13.62
170.00	-0.75	15.58	1.06	13.77

SCHWARZBECK MESS - ELEKTRONIK

An der Klinge 29 D-69250 Schönau Tel.: 06228/1001 Fax.: (49)6228/1003

Hochleistungs-Breitband Balun / Halter VHBD 9134-4 + BBAL 9136 Elemente High Power Broadband Balun / Holder VHBD 9134-4 + BBAL 9136 Elements

Frequency	Gain(Isotr.) 1 m	Ant.-Factor 1 m	Gain(Isotr.) 3 m	Ant.-Factor 3 m
MHz	dBm	dB/m	dBm	dB/m
171.00	-0.82	15.70	0.97	13.91
172.00	-0.88	15.81	0.89	14.05
173.00	-0.95	15.93	0.79	14.19
174.00	-1.01	16.04	0.71	14.33
175.00	-1.08	16.16	0.64	14.44
176.00	-1.15	16.28	0.62	14.51
177.00	-1.18	16.36	0.63	14.55
178.00	-1.18	16.41	0.66	14.57
179.00	-1.21	16.49	0.61	14.67
180.00	-1.30	16.62	0.49	14.84
181.00	-1.42	16.79	0.29	15.09
182.00	-1.47	16.90	-0.01	15.43
183.00	-1.41	16.88	0.02	15.45
184.00	-1.35	16.87	0.11	15.41
185.00	-1.33	16.89	0.33	15.23
186.00	-1.39	17.00	0.32	15.29
187.00	-1.44	17.10	0.33	15.33
188.00	-1.50	17.20	0.33	15.37
189.00	-1.58	17.33	0.28	15.47
190.00	-1.66	17.46	0.18	15.61
191.00	-1.78	17.62	0.04	15.80
192.00	-1.92	17.80	-0.13	16.02
193.00	-2.02	17.95	-0.27	16.20
194.00	-2.07	18.04	-0.34	16.32
195.00	-2.13	18.15	-0.37	16.39
196.00	-2.26	18.32	-0.43	16.49
197.00	-2.43	18.54	-0.54	16.65
198.00	-2.60	18.75	-0.66	16.81
199.00	-2.74	18.93	-0.79	16.99
200.00	-2.88	19.12	-0.95	17.19
201.00	-3.05	19.33	-1.18	17.46
202.00	-3.21	19.53	-1.44	17.77
203.00	-3.35	19.72	-1.71	18.08
204.00	-3.48	19.89	-1.98	18.39
205.00	-3.62	20.08	-2.19	18.65
206.00	-3.79	20.29	-2.40	18.89
207.00	-3.99	20.53	-2.62	19.16
208.00	-4.20	20.78	-2.89	19.47
209.00	-4.38	21.01	-3.15	19.78
210.00	-4.52	21.19	-3.37	20.03
211.00	-4.67	21.37	-3.55	20.26
212.00	-4.83	21.57	-3.73	20.48
213.00	-5.07	21.86	-3.88	20.66
214.00	-5.36	22.19	-4.05	20.88
215.00	-5.71	22.58	-4.29	21.15
216.00	-6.09	23.00	-4.61	21.52
217.00	-6.53	23.48	-5.06	22.01
218.00	-7.09	24.08	-5.68	22.67
219.00	-7.82	24.85	-6.50	23.53

SCHWARZBECK MESS - ELEKTRONIK

An der Klinge 29 D-69250 Schönau Tel.: 06228/1001 Fax.: (49)6228/1003

Hochleistungs-Breitband Balun / Halter VHBD 9134-4 + BBFA 9146 Elemente High Power Broadband Balun / Holder VHBD 9134-4 + BBFA 9146 Elements

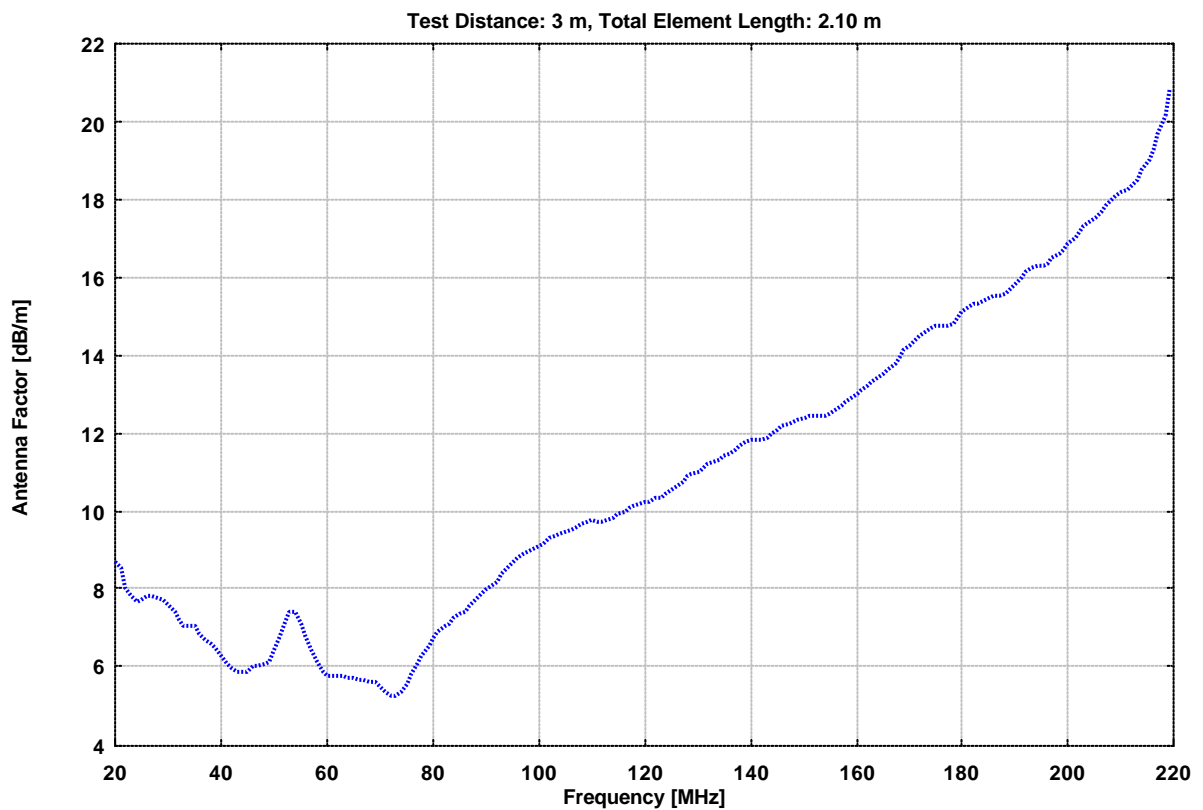
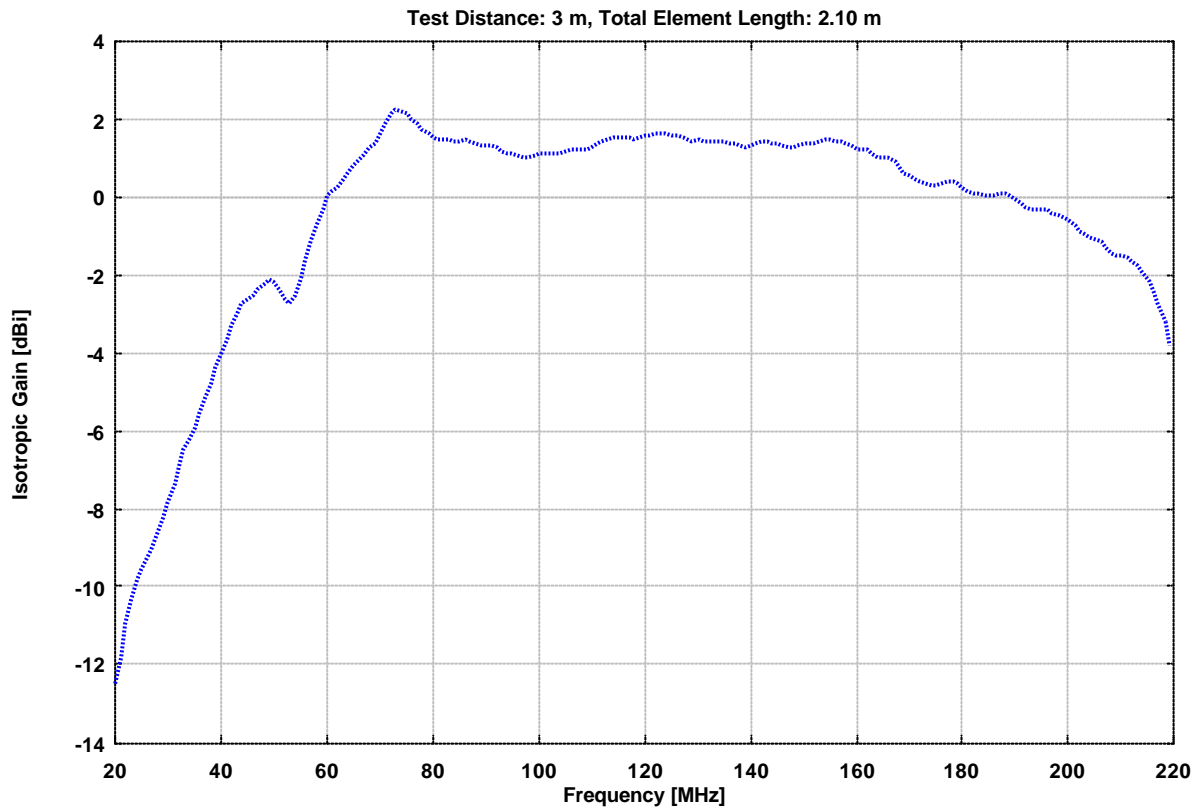

BBFA 9146 Elements without extensions folded to 1 m diameter

SCHWARZBECK MESS - ELEKTRONIK

An der Klinge 29 D-69250 Schönau Tel.: 06228/1001 Fax.: (49)6228/1003

Hochleistungs-Breitband Balun / Halter VHBD 9134-4 + BBFA 9146 Elemente High Power Broadband Balun / Holder VHBD 9134-4 + BBFA 9146 Elements

Frequency	Distance	Gain(Isotr.)	Ant.-Factor
MHz	m	dBi	dB/m
20.00	3.00	-12.47	8.71
21.00	3.00	-11.84	8.51
22.00	3.00	-10.99	8.05
23.00	3.00	-10.33	7.79
24.00	3.00	-9.85	7.68
25.00	3.00	-9.53	7.71
26.00	3.00	-9.27	7.79
27.00	3.00	-9.01	7.85
28.00	3.00	-8.61	7.78
29.00	3.00	-8.23	7.70
30.00	3.00	-7.84	7.60
31.00	3.00	-7.37	7.42
32.00	3.00	-6.87	7.19
33.00	3.00	-6.47	7.06
34.00	3.00	-6.22	7.07
35.00	3.00	-5.93	7.03
36.00	3.00	-5.52	6.87
37.00	3.00	-5.12	6.70
38.00	3.00	-4.76	6.58
39.00	3.00	-4.41	6.45
40.00	3.00	-4.02	6.28
41.00	3.00	-3.64	6.11
42.00	3.00	-3.31	5.99
43.00	3.00	-2.97	5.85
44.00	3.00	-2.74	5.83
45.00	3.00	-2.61	5.90
46.00	3.00	-2.53	6.01
47.00	3.00	-2.37	6.03
48.00	3.00	-2.21	6.05
49.00	3.00	-2.12	6.15
50.00	3.00	-2.17	6.37
51.00	3.00	-2.38	6.75
52.00	3.00	-2.62	7.16
53.00	3.00	-2.72	7.42
54.00	3.00	-2.53	7.40
55.00	3.00	-2.10	7.12
56.00	3.00	-1.59	6.78
57.00	3.00	-1.10	6.44
58.00	3.00	-0.65	6.14
59.00	3.00	-0.27	5.90
60.00	3.00	0.03	5.76
61.00	3.00	0.17	5.76
62.00	3.00	0.28	5.79
63.00	3.00	0.44	5.77
64.00	3.00	0.65	5.69
65.00	3.00	0.80	5.68
66.00	3.00	0.95	5.66
67.00	3.00	1.09	5.65
68.00	3.00	1.27	5.60
69.00	3.00	1.39	5.60
70.00	3.00	1.61	5.51

SCHWARZBECK MESS - ELEKTRONIK

An der Klinge 29 D-69250 Schönau Tel.: 06228/1001 Fax.: (49)6228/1003

Hochleistungs-Breitband Balun / Halter VHBD 9134-4 + BBFA 9146 Elemente High Power Broadband Balun / Holder VHBD 9134-4 + BBFA 9146 Elements

Frequency	Distance	Gain(Isotr.)	Ant.-Factor
MHz	m	dBi	dB/m
71.00	3.00	1.88	5.37
72.00	3.00	2.14	5.23
73.00	3.00	2.25	5.23
74.00	3.00	2.23	5.37
75.00	3.00	2.14	5.58
76.00	3.00	2.01	5.82
77.00	3.00	1.88	6.07
78.00	3.00	1.76	6.30
79.00	3.00	1.64	6.53
80.00	3.00	1.55	6.73
81.00	3.00	1.48	6.91
82.00	3.00	1.48	7.02
83.00	3.00	1.48	7.13
84.00	3.00	1.45	7.25
85.00	3.00	1.44	7.36
86.00	3.00	1.48	7.43
87.00	3.00	1.47	7.54
88.00	3.00	1.41	7.70
89.00	3.00	1.32	7.89
90.00	3.00	1.32	7.98
91.00	3.00	1.32	8.08
92.00	3.00	1.28	8.22
93.00	3.00	1.18	8.41
94.00	3.00	1.14	8.54
95.00	3.00	1.11	8.66
96.00	3.00	1.10	8.77
97.00	3.00	1.07	8.89
98.00	3.00	1.07	8.97
99.00	3.00	1.10	9.04
100.00	3.00	1.11	9.11
101.00	3.00	1.11	9.20
102.00	3.00	1.11	9.29
103.00	3.00	1.12	9.36
104.00	3.00	1.14	9.42
105.00	3.00	1.17	9.47
106.00	3.00	1.20	9.52
107.00	3.00	1.23	9.58
108.00	3.00	1.23	9.66
109.00	3.00	1.24	9.73
110.00	3.00	1.28	9.77
111.00	3.00	1.37	9.76
112.00	3.00	1.46	9.75
113.00	3.00	1.51	9.77
114.00	3.00	1.53	9.83
115.00	3.00	1.54	9.90
116.00	3.00	1.53	9.98
117.00	3.00	1.52	10.07
118.00	3.00	1.50	10.15
119.00	3.00	1.52	10.21
120.00	3.00	1.56	10.24
121.00	3.00	1.62	10.26

SCHWARZBECK MESS - ELEKTRONIK

An der Klinge 29 D-69250 Schönau Tel.: 06228/1001 Fax.: (49)6228/1003

Hochleistungs-Breitband Balun / Halter VHBD 9134-4 + BBFA 9146 Elemente High Power Broadband Balun / Holder VHBD 9134-4 + BBFA 9146 Elements

Frequency	Distance	Gain(Isotr.)	Ant.-Factor
MHz	m	dBi	dB/m
122.00	3.00	1.64	10.30
123.00	3.00	1.65	10.37
124.00	3.00	1.64	10.45
125.00	3.00	1.63	10.53
126.00	3.00	1.59	10.64
127.00	3.00	1.52	10.78
128.00	3.00	1.48	10.89
129.00	3.00	1.47	10.96
130.00	3.00	1.48	11.02
131.00	3.00	1.46	11.11
132.00	3.00	1.44	11.19
133.00	3.00	1.45	11.25
134.00	3.00	1.45	11.31
135.00	3.00	1.43	11.40
136.00	3.00	1.40	11.49
137.00	3.00	1.37	11.59
138.00	3.00	1.33	11.69
139.00	3.00	1.30	11.78
140.00	3.00	1.32	11.82
141.00	3.00	1.38	11.82
142.00	3.00	1.43	11.83
143.00	3.00	1.44	11.89
144.00	3.00	1.40	11.99
145.00	3.00	1.36	12.09
146.00	3.00	1.33	12.18
147.00	3.00	1.30	12.27
148.00	3.00	1.30	12.32
149.00	3.00	1.33	12.35
150.00	3.00	1.37	12.37
151.00	3.00	1.39	12.41
152.00	3.00	1.42	12.43
153.00	3.00	1.47	12.44
154.00	3.00	1.50	12.47
155.00	3.00	1.51	12.52
156.00	3.00	1.47	12.61
157.00	3.00	1.44	12.70
158.00	3.00	1.39	12.80
159.00	3.00	1.33	12.92
160.00	3.00	1.26	13.04
161.00	3.00	1.23	13.13
162.00	3.00	1.21	13.21
163.00	3.00	1.14	13.32
164.00	3.00	1.07	13.45
165.00	3.00	1.03	13.54
166.00	3.00	0.99	13.63
167.00	3.00	0.91	13.77
168.00	3.00	0.78	13.95
169.00	3.00	0.66	14.12
170.00	3.00	0.56	14.27
171.00	3.00	0.48	14.40
172.00	3.00	0.41	14.52
173.00	3.00	0.35	14.63

SCHWARZBECK MESS - ELEKTRONIK

An der Klinge 29 D-69250 Schönau Tel.: 06228/1001 Fax.: (49)6228/1003

Hochleistungs-Breitband Balun / Halter VHBD 9134-4 + BBFA 9146 Elemente High Power Broadband Balun / Holder VHBD 9134-4 + BBFA 9146 Elements

Frequency	Distance	Gain(Isotr.)	Ant.-Factor
MHz	m	dBi	dB/m
174.00	3.00	0.32	14.71
175.00	3.00	0.32	14.76
176.00	3.00	0.35	14.78
177.00	3.00	0.39	14.79
178.00	3.00	0.41	14.82
179.00	3.00	0.34	14.94
180.00	3.00	0.23	15.10
181.00	3.00	0.14	15.24
182.00	3.00	0.11	15.32
183.00	3.00	0.10	15.37
184.00	3.00	0.08	15.44
185.00	3.00	0.07	15.49
186.00	3.00	0.09	15.52
187.00	3.00	0.12	15.54
188.00	3.00	0.12	15.59
189.00	3.00	0.06	15.69
190.00	3.00	-0.04	15.83
191.00	3.00	-0.15	16.00
192.00	3.00	-0.26	16.15
193.00	3.00	-0.32	16.25
194.00	3.00	-0.31	16.29
195.00	3.00	-0.30	16.32
196.00	3.00	-0.33	16.39
197.00	3.00	-0.41	16.51
198.00	3.00	-0.47	16.62
199.00	3.00	-0.52	16.72
200.00	3.00	-0.60	16.84
201.00	3.00	-0.72	17.01
202.00	3.00	-0.85	17.18
203.00	3.00	-0.95	17.32
204.00	3.00	-1.03	17.44
205.00	3.00	-1.08	17.53
206.00	3.00	-1.16	17.66
207.00	3.00	-1.29	17.83
208.00	3.00	-1.42	18.00
209.00	3.00	-1.50	18.12
210.00	3.00	-1.51	18.18
211.00	3.00	-1.54	18.25
212.00	3.00	-1.62	18.37
213.00	3.00	-1.75	18.54
214.00	3.00	-1.93	18.76
215.00	3.00	-2.14	19.01
216.00	3.00	-2.40	19.31
217.00	3.00	-2.73	19.68
218.00	3.00	-3.18	20.17
219.00	3.00	-3.81	20.83